

Drain Gauge G3



Operator's Manual



Decagon Devices, Inc.

Version: August 28, 2015 — 09:58:39

Decagon Devices, Inc.
2365 NE Hopkins Court
Pullman WA 99163

Phone: 509-332-5600

Fax: 509-332-5158

Website: www.decagon.com

Email: support@decagon.com or sales@decagon.com

Trademarks

©2014 Decagon Devices, Inc.

All Rights Reserved

Contents

1	Introduction	1
1.1	Customer Support	1
1.2	Specifications	2
1.3	Warranty	4
2	How the G3 Works	5
2.1	Theory	5
2.2	Depth of Installation/Root Incursion	7
2.3	Divergence/Convergence of Soil Water	8
2.4	Soil Disturbance	11
2.5	Soil-Wick Contact	11
3	Installing the G3	12
3.1	Location Selection	12
3.2	Installation Depth	13
3.3	Collecting an Intact Soil Monolith in the DCT	13
3.4	Assembling the Drain Gauge G3	15
3.5	Making the Installation Hole	16
3.6	Installing the Apparatus	17
3.7	Installing the Sensor	19
3.8	Above Ground Tubing Terminations	20
3.9	EC Sensor Cleaning	22
4	Using the Drain Gauge G3	23
4.1	Collecting Water	23
4.2	Measuring Drainage (with sensor)	24
4.3	Calculating Concentration	25
5	Calibration	27
6	Connecting Sensors	28
6.1	3.5 mm Stereo Plug Wiring	29
7	Communication	31
7.1	Decagon Serial String	31
7.2	SDI-12 commands	32
7.3	SDI-12 Sensor Bus	32
7.4	Power	33

7.5	Reading	33
8	DG3 AutoPump	34
8.1	About the AutoPump	34
8.2	Sensor Connection	34
8.3	Sample Collection Tube Connection	35
8.4	AutoPump Configuration	36
8.5	Status LED and Error LED	38
9	Troubleshooting	39
10	Further Reading	42
11	Declaration of Conformity	43
11.1	Em50 CE Compliance	43

1 Introduction

Thank you for purchasing the Drain Gauge G3. Decagon Devices designed the Drain Gauge G3 for long-term monitoring of soil water drainage, with an estimated minimum 10 year lifetime. The Drain Gauge G3 also has a collection system that allows for rapid sampling of drainage waters. This innovative device enables you to monitor soil water movement and chemical leaching accurately and affordably.

1.1 Customer Support

If you ever need assistance with your Drain Gauge G3, or if you just have questions or feedback, there are several ways to contact us. Customer service representatives are available to speak with you Monday through Friday, between 7am and 5pm Pacific time.

Note: If you purchased your Drain Gauge G3 through a distributor, please contact them for assistance.

E-mail:

support@decagon.com or sales@decagon.com

Phone:

509-332-5600

Fax:

509-332-5158

If contacting us by email or fax, please include as part of your message your instrument serial number, your name, address, phone, and fax number.

1.2 Specifications

Measurement	Accuracy	Resolution	Range
Drainage	± 1.4 mm	0.2 mm	0 - 61 mm bottom of wick and 61 - 100 mm top of reservoir chamber
Water Depth	0.1% of full scale	0.5 mm	0 to 3,500 mm
Temperature	± 1 °C	0.1 °C	-11°C to 49°C
Bulk EC	± 0.01 dS/m or $\pm 10\%$ (Whichever is greatest)	0.001 dS/m	0 to 120 dS/m (bulk)

General

Measurement Time: 300 ms (milliseconds)

Power Requirements: 3.6 - 15 VDC, 0.03 mA quiescent, 10 mA during 300 ms measurement

Output: Serial (TTL), 3.6 voltage levels or SDI-12

Operating Temperature: 0 to 50 °C

Connector Types: 3.5 mm (stereo) plug or stripped & tinned lead wires (Pigtail)

Cable Length: 5 m standard; custom length available upon request

Data Logger Compatibility (not exclusive):

Decagon: Em50, Em50R, Em50G

Campbell Scientific: Loggers with serial I/O including CR10X, CR23X, any CRBasic type logger (CR850, 1000, 3000, etc.)

Other: Any data acquisition system capable of 3.6 - 15 V excitation and serial or SDI-12 communication

Handheld Reader Compatibility: ProCheck (rev 1.34+)

Software Compatibility: ECH₂O Utility (rev 1.64+), DataTrac 3 (rev 3.4+)

Suction at intake: 110 cm (11 kPa)

Solution collection capacity: 3.1 L (6.1 cm of drainage) to bottom of wick. Additional 5.1 L (10 cm of drainage) of reserve capacity in reservoir chamber

Solution collection surface area: 507 cm² (25.4 cm inside diameter)

Solution extraction: Maximum extraction depth approximately 8 m

Wetted Materials

DCT (standard): 304 stainless steel 11 gauge

DCT (optional inert material): PVC

Wick: dry fired fiberglass

Root inhibitor: Treflan (BioBarrier TM), removable

Sample evacuation tube: Polyethylene

Hydraulic bridge material: Diatomaceous Earth (DE)

All other parts: PVC

Dimensions

Total length: 147 cm

DCT length: 63.5 cm

DCT (outside) diameter: 26.4 cm

Reservoir length: 81.3 cm

Reservoir (outside) diameter: 11.5 cm

Access tube length: 180 cm standard, customizable

Access tube, outside diameter: 6.0 cm (2" schedule 40 PVC)

Sample evacuation tube: 1.27 cm OD X 0.79 cm ID X 5 m length
(standard)

Mass: 20 kg with Stainless Steel DCT, 14 kg with PVC DCT

1.3 Warranty

The Drain Gauge G3 has a one year warranty on parts and labor. The warranty activates when the instrument arrives at your location.

Seller's Liability

Seller warrants new equipment of its own manufacture against defective workmanship and materials for a period of one year from date of receipt of equipment (the results of ordinary wear and tear, neglect, misuse, accident and excessive deterioration due to corrosion from any cause are not to be considered a defect); but Seller's liability for defective parts shall in no event exceed the furnishing of replacement parts F.O.B. the factory where originally manufactured. Material and equipment covered hereby which is not manufactured by Seller shall be covered only by the warranty of its manufacturer. Seller shall not be liable to Buyer for loss, damage or injuries to persons (including death), or to property or things of whatsoever kind (including, but not without limitation, loss of anticipated profits), occasioned by or arising out of the installation, operation, use, misuse, nonuse, repair, or replacement of said material and equipment, or out of the use of any method or process for which the same may be employed. The use of this equipment constitutes Buyer's acceptance of the terms set forth in this warranty. There are no understandings, representations, or warranties of any kind, express, implied, statutory or otherwise (including, but without limitation, the implied warranties of merchantability and fitness for a particular purpose), not expressly set forth herein.

2 How the G3 Works

Install the Drain Gauge G3 below the root zone. Water infiltrates down through the soil and enters the divergence control tube (DCT). It then flows down through a fiberglass wick into a reservoir (see Figure 1). The water is stored in a measurement reservoir until a sample can be removed. The depth of the water in the reservoir or volume of the removed sample can be used to calculate the total drainage since the last date the reservoir was emptied. Chemical analysis can also be performed on the sample. With the drainage rate and chemical concentration in the drainage water, you can calculate the chemical flux through the soil .

2.1 Theory

A soil water balance takes into consideration the inputs, losses and storage of water in a soil profile. An important component of the water balance is the water that drains from the bottom of the soil profile, often referred to as “deep drainage” or “deep percolation.” This is water that has gone sufficiently far below the root zone that it cannot be removed from the soil by transpiration or evaporation. The other components of the water balance can be measured, but the deep drainage typically has been computed as the residual after measuring and accounting for the other components. Because of uncertainties in the measurements of the other water balance components, deep drainage estimates were subject to large errors.

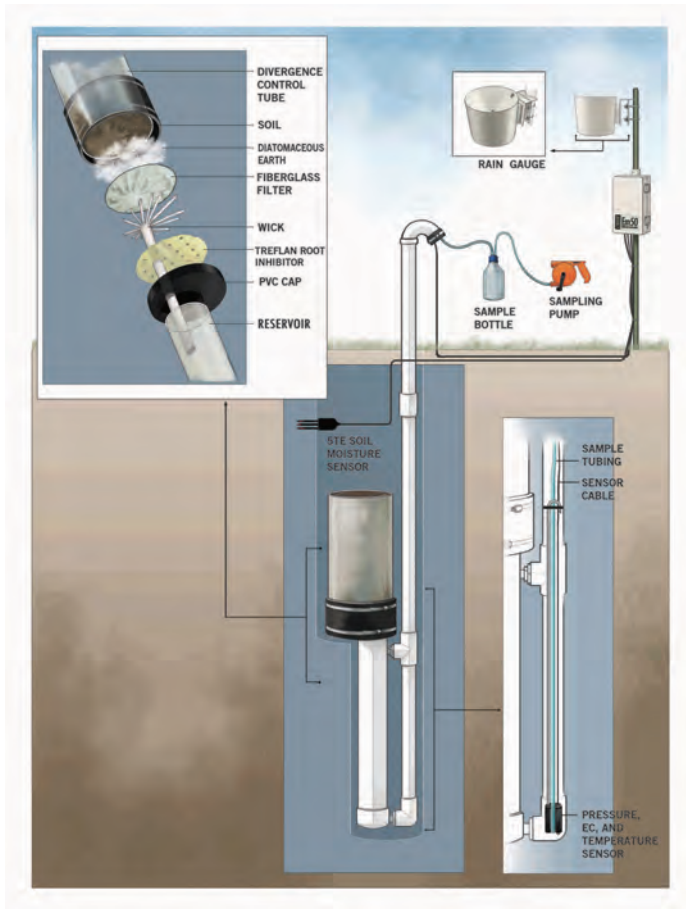

Figure 1: Components of the Drain Gauge G3

The Drain Gauge G3 allows direct measurement of the deep drainage component of the water balance. It accomplishes this measurement by intercepting and collecting a representative sample of the water that moves below the root zone. The Drain Gauge G3 is sometimes referred to as a passive wick lysimeter. It has a specially treated fiberglass wick which maintains tension on the water at the bottom of the soil profile where it is extracting water. Without this tension, water would “pile up” at the outflow boundary, and force the water in the soil above to move around the Drain Gauge G3, rather than into it. The divergence control tube (DCT) on the top of the Drain

Gauge G3 is also for the purpose of maintaining vertical flow above the Gauge so that the Drain Gauge G3 intercepts a representative sample.

Both the amount of sample and its chemical composition need to be representative of deep drainage in the area where you install the Drain Gauge G3. Installation determines whether or not the water drains adequately. There are four main issues covered by section 2.2 through 2.5.

1. Depth of installation and root incursion
2. Soil water divergence/convergence
3. Soil disturbance above the Drain Gauge G3.
4. Contact between the wick and the soil profile.

2.2 Depth of Installation/Root Incursion

In any soil profile, there is a zone of recharge and seasonal depletion extending to the bottom of the root zone. Place the Drain Gauge G3 with the union between the DCT and the wick section below the root zone of the cover vegetation.

If you place the union between the DCT and the wick section in the root zone, the Drain Gauge G3 can intercept water that normally would be transpired from the soil by the vegetative cover, thus overestimating the amount of drainage. There have also been cases of roots growing down through the wick and impeding flow through the wick as well as pulling water from the reservoir, thereby reducing the amount of measured drainage substantially.

A patch of BiobarrierTM root inhibitor fabric comes with each Drain Gauge G3. This fabric has beads impregnated with trifluralin which prevents root tip cell division and thereby acts as a root elongation inhibitor with 20 plus years of effective lifetime. This fabric has been shown to effectively keep roots from penetrating the Drain Gauge G3 wick section. In some situations where trifluralin or trifluralin breakdown products might compromise specialized chemical analy-

sis of drainage water, the Biobarrier fabric can be removed from the Drain Gauge G3 assembly.

Contact Decagon for instructions on removing the Biobarrier fabric without compromising the effectiveness of the capillary wick system. In cases where you remove the Biobarrier fabric, it is critical to bury the Drain Gauge G3 below the root zone.

Since root density decreases with depth, the bottom of this zone may be difficult to locate. In annual crops, the bottom is typically around 1 m (3 ft.), but can be much deeper in perennials. There is a practical limit to how deep you can install the Drain Gauge G3. With shallow-rooted crops this is not an issue, but with deep-rooted plants, operators must strike a compromise between getting below all roots and installing the Drain Gauge G3 at a practical depth. Even when roots go quite deep, the amount of water taken up by these roots may be small, so installing the Drain Gauge G3 within the lower root zone helps minimize errors. However, if you install the Drain Gauge G3 in the root zone it is essential to include the Biobarrier root inhibitor to prevent root incursion into the wick.

It is standard practice to place the upper section of the DCT in the root zone as long as vegetation is again established above the Drain Gauge G3 and normal root growth is present in the DCT. In some instances where the root zone is nonexistent or shallow (e.g. bare soil, turfgrass), it is possible to install the Drain Gauge G3 with the DCT extending all the way to the surface. This type of installation has the advantage of preventing flow divergence or convergence. However, it can be difficult to re-establish natural surface conditions and surface vegetation if the DCT extends to the surface.

2.3 Divergence/Convergence of Soil Water

Water in the soil flows in response to differences in soil suction, which is the same as water potential, but with the opposite sign. The two components of soil suction that are important in the water balance are the matric suction, which arises from the attraction between water and soil particle surfaces, and the gravitational suction which

arises from gravitational forces pulling on the soil water. The important thing to understand is that water always flows from low suction (high water potential) to high suction (low water potential). Suction in the soil generally ranges from 0 (saturation) to 100,000 kPa (air dry).

The suction at which there is no longer enough water in the soil to allow significant gravitational drainage is generally between 10 kPa and 33 kPa, and is known as field capacity. For water to enter a lysimeter, the suction at the intake must be equal to or greater than the suction in the surrounding soil. With traditional pan lysimeters, there is a zero suction boundary, which means that water preferentially flows around the lysimeter intake (flux divergence) unless the soil suction is very close to zero (saturation). This results in significant underestimation of drainage rates with pan lysimeters.

The Drain Gauge G3 uses a fiberglass wick to form a hanging water column which pulls continuous suction at the intake. In a perfect system, this suction would vary to match the matric suction of the surrounding soil allowing water to flow into the Drain Gauge G3 in exactly the same manner as it flows through the soil. However, the wick system is only able to pull a constant suction. The suction at the top of the DCT is approximately 11 kPa (50 cm wick plus 60 cm soil column in DCT). If the soil is drier than 11 kPa, water preferentially diverges around the Drain Gauge G3. Conversely, if the soil is wetter than 11 kPa, water preferentially flows into the Drain Gauge G3 (flux convergence). The chosen suction value of 11 kPa is an intermediate value between saturation and field capacity, which define the range of suctions where a significant amount of water drains through the soil. During very wet periods and during periods between 11 and 33 kPa of suction, the Drain Gauge G3 may experience flux divergence. However, the overall integrated flux measurement should be close to the actual drainage.

In addition to the fiberglass wick, the Drain Gauge G3 makes use of an innovative divergence control tube (DCT) that serves to minimize flux divergence and convergence and optimize collection efficiency of the Drain Gauge G3. Numerical and laboratory simulations per-

formed by Gee et al. (2009) have demonstrated the effectiveness of DCT in preventing flux divergence and convergence around the collection point. Figure 2 shows the modeled collection efficiency of the passive wick lysimeters such as the Drain Gauge G3 as a function of DCT height for six different flux rates in four different soils. (the Drain Gauge G3 DCT is 60 cm long)

In coarse textured or structured soils, the Drain Gauge G3 achieves reasonable collection efficiency with the standard 60 cm DCT even at low drainage flux rates. In nonstructured, fine textured soils, the standard 60 cm DCT only results in reasonable collection efficiencies at high drainage flux rates. However, the simulations were conducted with steady state drainage fluxes, which would seldom (if ever) occur in nature. Typically, drainage occurs with pulsed infiltration events (e.g. rainfall, irrigation, snow melt), where relatively high drainage fluxes increase the overall integrated collection efficiency of the Drain Gauge G3.

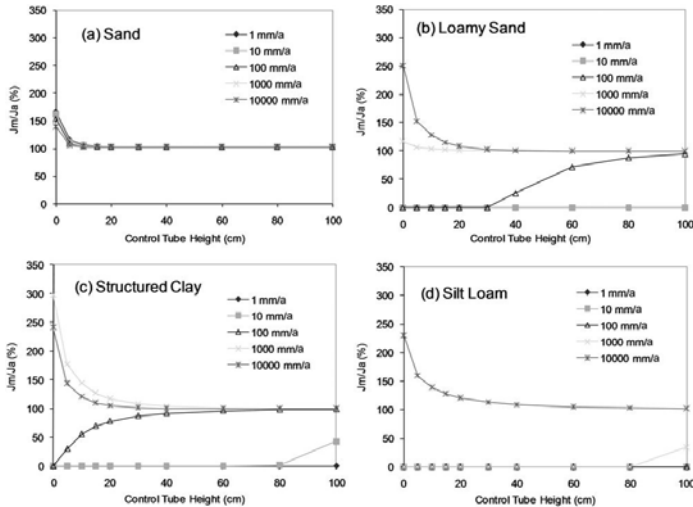

Figure 2: Simulated collection efficiency as a percentage ($\frac{J_m}{J_a} = 100 \times \frac{\text{measured}}{\text{actual}}$) for passive wick lysimeters with 60 cm long wicks in selected soils under a variety of steady state flux conditions and DCT heights. Figures from Gee et al. (2009).

2.4 Soil Disturbance

It is impossible to install the Drain Gauge G3 without disturbing the soil. The goal is to install it in such a way that the disturbance has minimal impact on the Gauge ability to measure deep drainage accurately. In some cases, it may be necessary to install the Drain Gauge G3 beneath an undisturbed core of soil.

In all cases it is necessary to allow time for roots to grow back into disturbed soil. If the soil surface is tilled, there is no point in trying to keep that part of the soil undisturbed, since it is already disturbed. The following chapter on installing the Drain Gauge G3 has some specific tips on how to minimize soil disturbance during installation.

2.5 Soil-Wick Contact

In order for the bottom of the soil profile to be under the proper suction, the suction in the wick must be transferred to the bottom of the soil column. There must therefore be good capillary continuity between the soil column and the wick. If the Drain Gauge G3 is installed by backfilling with soil, the contact is likely to be good without further effort. If an undisturbed core is installed, capillary continuity is established by placing a layer of diatomaceous earth over the wick. The diatomaceous earth conforms to the irregularities of the soil and wick to provide continuity.

3 Installing the G3

3.1 Location Selection

The location that is chosen for Drain Gauge G3 installation must match the objectives of the particular drainage study. For many studies, an estimate of the average groundwater recharge from the study site is desired. In this case, it is important to choose installation location(s) that are representative of the study site as a whole, and several characteristics of the study site must be accounted for three main items.

1. **Vegetation:** Once water has percolated more than a few centimeters into the soil, the main mechanism by which water is transported from the soil to the atmosphere is through vegetative transpiration. It is desirable that the Drain Gauge G3 be installed at a location with vegetative cover that is representative of the whole area of interest. It is also particularly critical that vegetation be re-established above the Drain Gauge G3 after installation.
2. **Topography:** It is best to avoid low areas where runoff collection can cause uncharacteristically high drainage rates. Typically, most accurate drainage results are measured at locations with a level surface, although installations on slopes can yield good results if the installation location is properly restored to natural conditions.
3. **Location Disturbance:** For most accurate drainage measurement, it is critical to re-establish natural conditions above the Drain Gauge G3 after installation and is therefore best to disturb the location as little as possible during installation. With the Drain Gauge G3, significant location disturbance is inevitable, but there are strategies to minimize location disturbance. We suggest that you select one location for your installation, but select a second location nearby that you can use to collect an intact soil monolith in the DCT. The monolith location should be close enough to the installation location that soil properties are similar between the two locations, but far enough away that excavation activities at the monolith location don't

impact the installation location. This method allows you to use whatever methods are most convenient to fill the DCT with an intact monolith (i.e. heavy equipment), while still minimizing disturbance at your installation site. Typically, the site where the monolith is collected and the installation site are on the order of 10 m apart.

3.2 Installation Depth

The depth of the Drain Gauge G3 installation depends on the depth of the root zone. The objective of the installation is to place the union between the DCT and the wick section below the root zone of the cover vegetation. If the union between the DCT and the wick section is placed in the root zone, then the Drain Gauge G3 can intercept water that normally would be transpired from the soil by the vegetative cover, thus overestimating the amount of drainage. It is acceptable and expected that the upper section of the DCT be placed in the root zone as long as vegetation is re-established above the Drain Gauge G3 and normal root growth is present in the DCT.

Because the installation depth is determined by vegetative rooting depth, the depth of installation varies from location to location. In some instances where the root zone is nonexistent or shallow (e.g. bare soil, turf grass), it is possible to install the Drain Gauge G3 with the DCT extending all the way to the surface. This type of installation has the advantage of preventing flow divergence or convergence. However, it can be difficult to re-establish natural surface conditions and surface vegetation if the DCT is extended to the surface.

3.3 Collecting an Intact Soil Monolith in the DCT

Follow Steps one through seven to successfully collect an intact monolith or soil core in the DCT.

Note: These instructions are only for a Stainless Steel DCT.

1. If you do not wish to collect an intact soil core (monolith) in the DCT and would rather use a disturbed soil sample, skip this section and go straight to the Assembling the Drain Gauge G3 section below.
2. Select the location to collect the intact monolith. We recommend you collect the monolith at a separate (but nearby) location from where you install the Drain Gauge G3 (see the comments in the Location Selection section above).
3. Excavate to the level that you have determined to be optimal for the top of the DCT. See the Installation depth section above for help determining how deep the Drain Gauge G3 should be installed.
4. Place the DCT on the exposed soil in the hole that you have just excavated.
5. Press or pound the DCT into the soil. The most convenient method for inserting the DCT into the soil is to use heavy equipment (e.g. backhoe or front end loader) to apply the downward force. However, it is possible to pound the DCT into the soil with a heavy sledgehammer. With either method it is critical to distribute the insertion force to avoid damaging the top edge of the DCT. Place one or more 4" × 4" wood boards on the top edge of the DCT before pushing or pounding into the ground.

The amount of force needed to insert the DCT is reduced considerably by removing the soil around the portion of the DCT that has already been inserted. In other words, push or pound the DCT in for a few inches, dig down around the outside of the DCT and remove the soil to the depth of the cutting edge of the DCT, then repeat. In some situations (e.g. stony soil), it may not be possible to push or pound the DCT into the soil to collect an intact monolith. In this case, a re-packed monolith is the only option. See instructions for filling the DCT with soil in the Installing the apparatus section below for more information on this option.

6. Once the DCT has been fully inserted into the soil, dig a large

enough hole around it to access the bottom edge of the DCT. Use a flat blade or other utensil to cut the soil at the bottom edge of the DCT, resulting in a flat soil face at the lower boundary of the DCT.

7. Lift the DCT with intact monolith out of the hole.

3.4 Assembling the Drain Gauge G3

Once the installation depth has been chosen and the intact monolith has been collected in the DCT (if desired), you are ready to assemble the Drain Gauge G3.

1. Add a layer of diatomaceous earth (DE) on top of the fiberglass fabric on the top of the wick section or on the bottom of the DCT with the intact monolith. The DE ensures good hydraulic contact between the soil in the DCT and the wick, and also filters fine particulates from the drainage water, keeping the Drain Gauge G3 from accumulating soil or “silting up” over time.
2. Attach the DCT to the wick section. Loosen the screw on the hose clamp at the top of the rubber union sleeve until the hose clamp is visibly loose.
 - (a) Insert the DCT into the rubber union sleeve until the soil column at the bottom of the DCT seats snugly against the layer of DE. If the DCT does not contain an intact soil monolith, simply seat the bottom of the DCT against the fiberglass fabric. If you are having trouble getting the DCT into the rubber union sleeve, you can use a screwdriver or other thin object to work the rubber union sleeve out and around the DCT.
 - (b) Tighten the hose clamp until the rubber union sleeve is sealed to the DCT.
3. Extend the access tube to desired length. Determine the desired length by the depth of the Drain Gauge G3 installation. Typically, the top of the access tube should be one to three

feet above the ground surface. To extend the access tube, simply add the two enclosed sections of two inch schedule 40 PVC tubing connected by the slip coupling. You can customize the overall length of the access tube by cutting the second PVC section to the desired length or by adding additional PVC tubing. In areas with a high water table we recommended that you glue the PVC connections to prevent water from entering the access tube or sampling chamber.

3.5 Making the Installation Hole

1. Select a location for your installation (allow plenty of room to move around the hole) and lay a tarp nearby that you can use to hold the vegetation and soil to be removed from the site.
2. Remove the surface vegetation and place it on the tarp. Try to preserve as much of the root mass as possible. Also, it is important to organize the vegetation you remove so that it can be replaced as closely as possible to its original location(Figure 3)

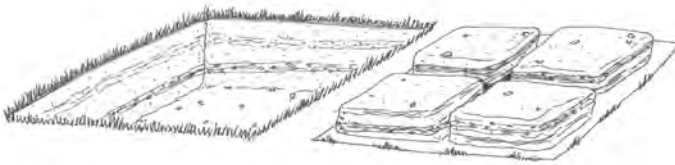

Figure 3: Initial Excavation for Drain Gauge G3 Installation

- Make a vertical hole at least 16 inches (41 cm) in diameter to the level of the junction between the DCT and the reservoir section (25 inches, 635 cm below the top of the DCT).
- Method #1 (offset holes). Starting at the floor of the 16 inch diameter hole, make a 10 inch (25.4 cm) diameter vertical hole to the depth of the bottom of the reservoir section (approximately 33 inches, 84 cm below the junction between the bottom of the 16 inch hole) to accommodate the reservoir section. The center of the 10 inch hole should be offset from the center of

the 16 inch hole by 3 inches. In other words, the outer edge of the 10 inch hole should be flush with the outer edge of the 16 inch hole. With the offset hole configuration, the shelf formed at the end of the 16 inch hole helps to support the weight of the Drain Gauge G3 during installation and minimizes the amount of backfilling necessary.

- Method #2 (straight hole). Continue the 16 inch vertical hole from #3 above to the depth of the bottom of the reservoir section (approximately 58 inches, 147 cm below the top of the DCT). This method is easier to accomplish in practice, but requires more significant backfilling of soil around the reservoir section of the Drain Gauge G3.

3.6 Installing the Apparatus

1. Loop a length of heavy rope or strap below the fitting connecting the reservoir section to the access tube immediately below the junction between the DCT and reservoir section (See figure 4 below).

Caution: If you are using an intact monolith, when turning the Drain Gauge G3 upright it is important to not lift the drain gauge up using the bottom part of the sampling chamber as a lift point. Doing this could result in a break around PVC fittings or the seal around the wick section.

2. Carefully lower the Drain Gauge G3 into the installation hole with one person holding the Drain Gauge G3 level and guiding it into the installation hole while another person(s) slowly lowers it into the hole using the loop of rope or strap (this job typically take two to three people slowly lower the Drain Gauge G3 into the hole). Do not drop the Drain Gauge G3 into the hole or it could be permanently damaged.
3. Filling the DCT with a disturbed sample (ignore this section if you collected an intact monolith in the DCT). If you did not collect an intact monolith it is important to re-pack the

disturbed soil in the DCT as similarly as possible to the natural soil conditions.

- (a) **Bulk density:** When backfilling the DCT, it is important to pack the soil back to the natural bulk density. Try to avoid large variations in bulk density between layers as these act to retard flow and can cause flux divergence.
 - (b) **Horizonation:** Try to pack the soil back into the DCT in layers that correspond to the horizons in the surrounding soil.
4. Carefully backfill soil into the hole around the reservoir section. The more soil you are able to backfill into this section the better, as the Drain Gauge G3 is less likely to settle over time if this section is full of soil.
5. Backfill soil around the DCT. Try to achieve a similar bulk density to the surrounding soil.
6. Carefully replace the soil above the DCT and vegetation that were removed as described at the beginning of making the installation hole section. Be careful to re-pack the soil above the DCT to the same bulk density as the surrounding soil and to re-create any layering that is present in the natural soil. Also be careful not to leave a mound or depression of soil above the Drain Gauge G3, as this could significantly affect infiltration of water in the area of the Drain Gauge G3.
7. If there is vegetative cover above the Drain Gauge G3, it may be desirable to “water in” the disturbed vegetation to help it re-establish as soon as possible.

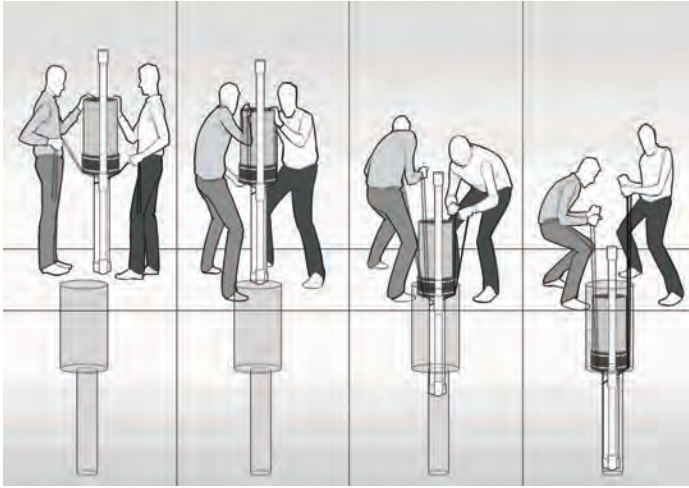

Figure 4: How to Safely Lower the Drain Gauge into the Installation Hole

3.7 Installing the Sensor

Now that you have the Drain Gauge G3 collection unit in the ground it is time to install the sensor and sample collection tube. First, you need to connect your sampling tube to the notch on the side base of the CTD-Drain Gauge sensor. Make sure that the sampling tube is seated all the way down in the notch. The sampling tube comes in a standard 3 m length but it can be ordered in custom lengths. You can zip tie the sampling tube to the sensor cable to help keep it secure.

Note: do not over tighten the tie, doing so could collapse the white vent tube of the transducer causing the sensor to not operate properly.

It is time to slowly lower the sensor down the access until it reaches the bottom of the access tube. The sensor is designed to fit snugly in the bottom of the access tube.

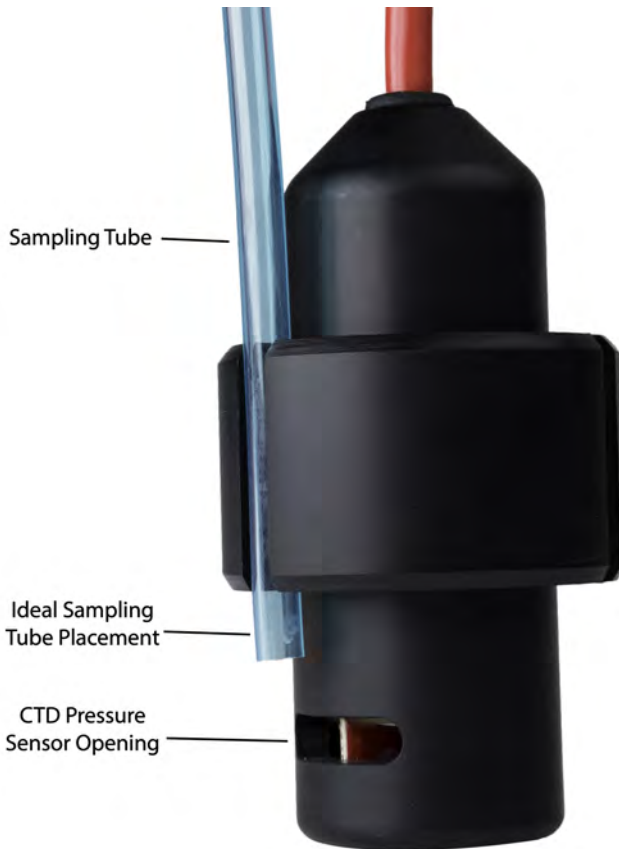

Figure 5: Sensor Assemble with Tube

Note: Do not install sampling tube below pressure sensor opening(CTD bottom notch).

3.8 Above Ground Tubing Terminations

1. Now that the Drain Gauge G3 is installed in the ground, the sampling tube and sensor cable coming out of the access tube need to be run through the “U” connector. Then connect the “U” connector to the top of the access tube.

2. After connecting the “U” connector to the access tube run the sampling tube and sensor cable through the pre-cut slit in the rubber end cap. Pull the sampling tube and sensor cable through the end cap until the end cap meets up with the end of the “U” connector. Be sure not to pull the sampling tube too tight, because doing so could cause the end of the sampling tube to be pulled up higher in the access tube. Connect the end cap with the end of the “U” connector and tighten the hose clamp with a flat head screwdriver.



Figure 6: PVC “U” Connector Assembly on Top of Access Tube

Priming the Drain Gauge G3

The end of the Drain Gauge G3 sample tube is situated slightly above the floor of the access tube. This is also slightly above the level of the floor of the reservoir section. This creates a “dead volume” of 135 mL of accumulated drainage water that cannot be removed using the sample tube. When the Drain Gauge G3 is first installed into the soil, this volume does not contain water, so a total of 135 mL of drainage water needs to accumulate before the Drain Gauge G3 begins to record drainage. We recommend that you prime the

Drain Gauge G3 after installation by adding 250 mL or more of water through the access tube. Then, you should remove all possible water by evacuating from the sample tube with the included pump. This effectively fills the dead volume and ensures the Drain Gauge 3 records any subsequent drainage.

Water Balance

It is often useful to install ECH₂O soil moisture sensors near the Drain Gauge G3 to observe how the water content changes with depth over time in the soil profile. Some users also install ECH₂O sensors in the DCT to make sure that the soil moisture dynamics in the DCT are similar to those in the undisturbed soil surrounding the Drain Gauge G3. If you install ECH₂O sensors in the DCT, you must take care so they are not touching any part of the DCT, because this adversely affects the readings. A good rule is to locate them as close to the center of the DCT as possible. Installing a drain gauge near the installation site is also useful for measuring incoming water values for water balance calculations.

3.9 EC Sensor Cleaning

A four electrode conductivity measurement is less sensitive to sensor fouling than a two electrode sensor, but contamination of the electrodes can still affect the measurement. The electrodes are stainless steel.

Cleaning Method

1. Rub the screws vigorously with a swab or clean cloth.
2. Rinse the sensor and screws thoroughly with tap or DI water. Be sure not to touch the screws with a bare hand or to contact them with any source of oil or other nonconducting residue.

4 Using the Drain Gauge G3

Overview

The Drain Gauge G3 measures the total drainage by accumulating a representative drainage sample in the reservoir section. If the volume of water accumulated in the reservoir section is divided by the cross sectional surface area of the intake of the DCT, the total drainage can be calculated with units of m^3 drainage/ m^2 soil surface area, or more simply *cm* of drainage.

The water in the reservoir section is easily accessed by the sample tube, and can be removed using the pump included with the Drain Gauge G3 for chemical analysis in the laboratory. If the concentration of the constituent of interest is measured, it can be multiplied by the drainage flux density to yield the flux density of the constituent through the soil.

4.1 Collecting Water

Supplied with the Drain Gauge G3 is a piston pump and a 1 L sampling bottle. The cap for the sampling bottle has two connectors for hoses. Connect the sample evacuation tube coming out of the drain gauge to one of the ports. Then connect supplied second hose from the other port in the sampling bottle to the inlet port of the piston pump. Begin rotating the handle on the pump counterclockwise continuously. This creates a vacuum inside of the sampling bottle pulling the collected drainage water out of the Drain Gauge G3 sampling reservoir and into the sampling bottle. Because the reservoir has a higher capacity than the sampling bottle, you may need to stop pumping if the sampling bottle becomes full and empty the solution into a secondary bottle. Continue this process until water stops flowing into the sampling bottle. The reservoir should now be empty. Use the total volume of your pulled sample to calculate drainage and contaminant flux rates.

In order to prevent cross contamination between samples and across different locations it is important to rinse out the sampling bottle

and associated parts before pulling another sample. Take apart the cap and bottle assembly and rinse all of the parts that came into contact with the sampled water using distilled water three times. The pump does not need to be rinsed out since it does not come into contact with any of the sampled water.

Note If the pump becomes hard to turn you may open the pump and apply lubricating grease to the internal apparatus.

4.2 Measuring Drainage (with sensor)

The CTD-Drain Gauge use a differential pressure transducer to measure the pressure being applied by the water column above the sensor. A direct relationship between pressure and water depth is used by the sensor to measure water depth and the known cross-sectional surface area of the water reservoir is used to calculate accumulated drainage. The reference port of the pressure transducer is vented through the cable to atmospheric pressure, so no reference barometric pressure is required. A porous Teflon vent near the data logger end of the cable provides the reference. The Teflon keeps liquid water out of the cable, but allows air to enter and leave. This vent must be kept open to the same atmospheric pressure that is applied to the water whose depth is being measured. Since the cable is conducting reference air between the sensor and the atmosphere, it is extremely important that the cable be protected from any damage that would allow water to enter.

Temperature

A thermistor near the electrical conductivity sensor senses the temperature of the water. This temperature is used to adjust the EC measurements to their 25 °C value, and provides the temperature output for the data stream.

Electrical Conductivity

Electrical conductivity (EC) is used to measure the concentration of salts in the water and also gives information about dissolved solids.

EC is measured by applying an alternating electrical current to two electrodes, measuring the current flow through those electrodes, and measuring voltage drop with a separate set of electrodes. The conductance is the ratio of current to voltage. Conductivity is conductance multiplied by a cell constant which is obtained using conductivity standards. It is important to realize that a 4 electrode sensor gives unpredictable readings in air because there is no connection between the voltage and current electrodes.

Calculating Drainage

The inner diameter of the DCT is 25.4 cm (10.0 inches), which yields a cross sectional surface area of 506.7 cm^2 (78.5 in^2) at the intake of the Drain Gauge G3. The amount of drainage can easily be calculated by the change in volume of water accumulated in the reservoir section. Simply divide the volume of water removed (cm^3) by the cross sectional surface area of the DCT intake (506.7 cm^2), yielding the total accumulated drainage in units of cm.

4.3 Calculating Concentration

Collected drainage water can be easily and quickly removed from the Drain Gauge G3 through the sample tube using the included pump and sampling bottle. The concentration of the constituent(s) of interest can then be determined through laboratory analysis.

The end of the Drain Gauge G3 sample tube is situated slightly above the floor of the access tube. If all possible water is removed to the level of the end of the sample tube, 135 mL of drainage water remains in the lowest portion of the access tube and in the lowest portion of the reservoir section. This drainage water mixes with any new soil solution that is collected by the Drain Gauge G3. The chemical concentration of a sample that is subsequently removed for analysis then represents a weighted average of the chemical concentration of the remnant drainage water and the newly accumulated drainage water. For many applications, this is acceptable, but for some, only the chemical concentration of the newly accumulated drainage water

is desired. This can be calculated by:

$$C_{new} = \frac{[(C_{mix}(V_{new} + V_{old})) - (C_{old} \times V_{old})]}{V_{new}} \quad (1)$$

Where C is constituent concentration, V is volume of drainage water, and the subscripts new, old, and mix indicate newly accumulated drainage water, drainage water remaining in the reservoir chamber after the previous extraction, and the mixture of the two types of drainage water respectively.

For Example. The nitrate concentration of drainage water that was removed from a Drain Gauge G3 just prior to fertilization of a corn crop was 30 mg/L. When the water was extracted a few weeks following application of urea, 500 mL of drainage water was extracted with a nitrate concentration of 45 $\frac{mg}{L}$.

$$\begin{aligned} C_{mix} &= 45 \frac{mg}{L} \\ V_{new} &= 500 \text{ mL} \\ V_{old} &= 135 \text{ mL} \\ C_{old} &= 30 \frac{mg}{L} \end{aligned}$$

$$C_{new} = \frac{[(45 \frac{mg}{L}(0.500L + 0.135L)) - (30 \frac{mg}{L} \times 0.135L)]}{0.500L} = 49.05 \frac{mg}{L} \quad (2)$$

For this calculation to be valid, the reservoir must be fully emptied to the level of the bottom of the sample tube during the evacuation previous to the analysis and during the evacuation used for the analysis.

Note: Because the Drain Gauge G3 is a completely sealed system and does not have an overflow tube, it needs to be emptied periodically to prevent the water level from reaching the bottom of the wick. If the water level reaches the wick it changes the tension that the wick applies as it continues to rise above the bottom of the wick. This does not cause damage to the Drain Gauge G3, but it may reduce your collection efficiencies.

5 Calibration

The water depth and EC sensors are calibrated at the factory, and calibration values are stored internally in flash memory. The depth sensor is calibrated at controlled pressures. The EC sensor is calibrated using KCl solutions of known concentration.

Table 1 relates electrical conductivity at 25 °C to concentration for various concentrations of KCl. You can verify performance of the CTD-Drain Gauge using these solutions. The CTD-Drain Gauge internally corrects output values to 25 °C.

Electrical conductivity of KCl solutions for testing the CTD-Drain Gauge calibrations.

Table 1

Electrical Conductivity ($\mu\text{S}/\text{cm}$)	g KCl per kg of distilled water
100	0.0446
200	0.0930
500	0.2456
1000	0.5120
2000	1.0673

6 Connecting Sensors

We designed the CTD-Drain Gauge to work most efficiently with Decagon's Em50, Em50R, Em50G data loggers, or our ProCheck handheld reader. The standard sensor (with 3.5 mm stereo connector) quickly connects to and is easily configured within a Decagon logger or ProCheck. The Decagon CTD-Drain Gauge incorporate several features that also make it an excellent sensor for use with third party loggers. The sensor may be purchased with stripped and tinned wires (pigtail) for terminal connections. Visit: www.decagon.com/support/li to get extensive directions on how to integrate the CTD-Drain Gauge into third party loggers.

The Decagon CTD-Drain Gauge arrives standard with a 10 meter cable. Sensors may be purchased with custom cable lengths for an additional fee (on a per-meter basis). Decagon has tested its digital sensors successfully up to 1000 meters (3200 ft). This option eliminates the need for splicing the cable (a possible failure point).

Connecting to an Em50 Series logger

We designed the Decagon CTD-Drain Gauge to work specifically with Em50 series data loggers. Simply plug the 3.5 mm "stereo" connector directly into one of the five sensor ports.

The next step is to configure your logger port for the instrument and set the measurement interval. This may be done using either ECH₂O Utility or ECH₂O Utility Mobile (see respective manuals). Please check your software version to ensure it supports the Decagon CTD-Drain Gauge. To update your software to the latest version, please visit Decagon's software and firmware download site: www.decagon.com/support/downloads.

The following firmware and software supports the Decagon CTD-Drain Gauge:

- Em50 Firmware version 2.19 or greater
- ECH₂O Utility 1.74 or greater
- ECH₂O DataTrac 3.11 or greater

Use the ECH₂O Utility, ECH₂O DataTrac or a terminal program on your computer to download data from the logger to your computer.

6.1 3.5 mm Stereo Plug Wiring



Figure 7: 3.5 mm Stereo Plug

Connecting to a Non-Decagon Logger

The Decagon CTD-Drain Gauge may be purchased for use with non-Decagon data loggers. These sensors typically come pre-configured with stripped and tinned (pigtail) lead wires for use with screw terminals. Refer to your logger manual for details on wiring. Our Integrator's Guide gives detailed instructions on connecting the CTD-Drain Gauge to non-Decagon loggers. Please visit www.decagon.com/support/literature for the complete Integrator's guide.

Pigtail End Wiring



Figure 8: Pigtail End Wiring

Connect the wires to the data logger as shown, with the supply wire (white) connected to the excitation (3.6 - 15 volts), the digital out wire (red) to a digital input, the black ground wire to analog ground and the bare ground wire to shield or earth ground.

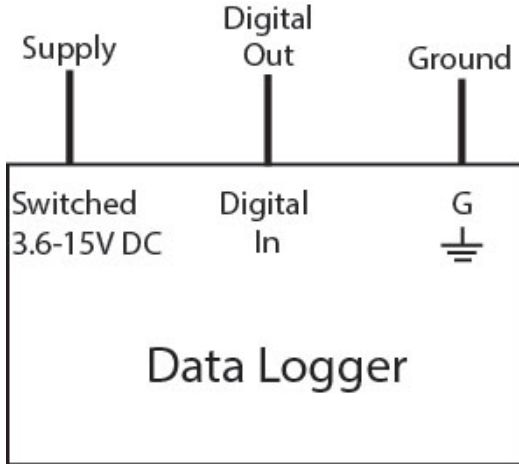

Figure 9: Wiring Configuration

If your Decagon CTD-Drain Gauge with the standard 3.5 mm plug, and you wish to connect them to a non-Decagon data logger, you have two options. First, you can clip off the plug on the sensor cable, strip and tin the wires, and wire it directly into the data logger. This has the advantage of creating a direct connection with no chance of the sensor becoming unplugged; however, it then cannot be easily used in the future with a Decagon readout unit or data logger.

The other option is to obtain an adapter cable from Decagon. The 3-wire sensor adapter cable has a connector for the sensor jack on one end, and three wires on the other end for connection to a data logger (this type of wire is often referred to as a “pigtail adapter”). Both the stripped and tinned adapter cable wires have the same termination as seen above; the white wire is excitation, red is output, and the bare and black wires are ground.

7 Communication

The Decagon CTD-Drain Gauge can communicate using two different methods, Decagon serial stream or SDI-12 communication protocol. This section briefly discuss the specifics of each of these communication methods. Please visit www.decagon.com/support/literature for the complete Integrator's guide, which gives more detailed explanations and instructions.

7.1 Decagon Serial String

When excitation voltage is applied, the Decagon CTD-Drain Gauge makes a measurement. Within about 140 ms of excitation three measurement values are transmitted to the data logger as a serial stream of ASCII characters. The serial out is 1200 baud asynchronous with 8 data bits, no parity, and one stop bit. The voltage levels are 0 to 3.6 V and the logic levels are TTL (active low). The power must be removed and reapplied for a new set of values to be transmitted. The ASCII stream contains three numbers separated by spaces. The first number is water depth in mm, the second number is temperature in C with a resolution of 0.1 C, and the third number is EC in mS/cm, with a resolution of 1 mS/cm. A carriage return follows the three numbers, then the character "v," indicating that this is a G3 sensor, then a checksum character, and finally a carriage return SDI-12 communication.

The CTD-Drain Gauge can also communicate using SDI-12 protocol, a three-wire interface where all sensors are powered (white wire), grounded (bare wire and black wire), and communicate (red wire) on shared nodes (for more information on the SDI-12 protocol, visit (www.sdi-12.org)). Below is a brief description of SDI-12 for communication. If you plan on using SDI-12 for communication with the CTD-Drain Gauge, please see our Integrator's Guide at www.decagon.com/support/literature for detailed instructions.

7.2 SDI-12 commands

The CTD-Drain Gauge responds to the following SDI-12 commands. The sensor address is shown as ‘a.’ If a is substituted for ‘a’ all addresses respond.

Table 2: SDI-12 Commands

Send Identification	AI!	a13DECAGON CTD+DG 316<CR><LF>
Change Address	aAb!	b<CR><LF> (b is new address)
Address Query	?!	a<CR><LF>
Start Measurement	aM!	00013<CR><LF>
Send Data	aD0!	a+9+22.2+0<CR><LF> (3 values)

7.3 SDI-12 Sensor Bus

Up to 62 sensors can be connected to the same 12 V supply and communication port on a data logger. This simplifies wiring because no multiplexer is necessary. However, one sensor problem can bring down the entire array (through a short circuit or incorrect address settings). If you use an SDI-12 sensor bus we recommend that you make an independent junction box with wire harnesses where all sensor wires attach to lugs so sensors can be disconnected individually if a problem arises. A single three-wire cable can be run from the junction box to the data logger.

SDI-12 address

The SDI-12 protocol requires that all sensors have a unique address. The CTD-Drain Gauge comes from the factory with an SDI-12 address of 0. To add more than one SDI-12 sensor to a system, the sensor address must be changed. Address options include 09, AZ, az. The best and easiest way to change an address is to use Decagon’s ProCheck (if the option is not available on your ProCheck, please upgrade to the latest version of firmware). SDI-12 addressing can

be accessed in the “CONFIG” menu by selecting “SDI-12 Address” Addresses may then be changed by simply pressing the up or down arrows until you see the desired address and pushing “Enter.”

The SDI-12 communication protocol is supported by Campbell Scientific data loggers like the CR10X, CR200, CR1000, CR3000, etc. Direct SDI-12 communication is supported in the “Terminal Emulator” mode under the “Tools” menu on the “Connect” screen. Detailed information on setting the address using CSI data loggers can be found on our website at <http://www.decagon.com/support/downloads>.

7.4 Power

The sensor can be powered using any voltage from 3.6 to 15 VDC, but 12 V is optimal. When using the sensor as part of an SDI-12 bus, it is recommended that the sensors be excited continuously to avoid issues with initial sensor startup interfering with the SDI-12 communications.

7.5 Reading

An example program from Edlog and CRBasic can be found in our software section online at <http://www.decagon.com/support/downloads>. As with the Decagon Serial String, the water depth is the first number output by the sensor, in mm. The second number is temperature in Celsius. The third number is electrical conductivity, in $\frac{\mu S}{cm}$

8 DG3 AutoPump

8.1 About the AutoPump

In many applications where you are measuring deep drainage there are periods of times where there may be higher volumes of drainage occurring. Because the Drain Gauge G3 captures all of the drainage it measures there is a chance the reservoir can become full. The Drain Gauge G3 can handle up to 61 mm of drainage before the water level comes in contact with the wick. After this point there is a chance the water can be pulled out of the reservoir due to capillary rise. This results in an under estimation of deep drainage. This becomes a big problem at remote or high drainage sites. We designed the AutoPump to drain the reservoir of the Drain Gauge G3 when it becomes full. The water can be pumped into additional bottles on the surface for later collection or drained into the field at a point away from the measurement area of the Drain Gauge.

8.2 Sensor Connection

We designed the AutoPump to sit on the surface near the access port for the Drain Gauge G3. The Drain Gauge G3 Sensor or CTD+DG connects to the sensor port inside the case (Figure 10). There is a cable gland on the lid of the AutoPump where the cable will be slotted through and sealed up to keep the case weather proof. Be sure to leave enough slack in the cable to allow easy opening of the case without putting stress on the connection. There is another cable with a 3.5 mm stereo end that comes out from the case and can connect to the Data logger. Follow the same logger configuration steps outlined in Section 6.

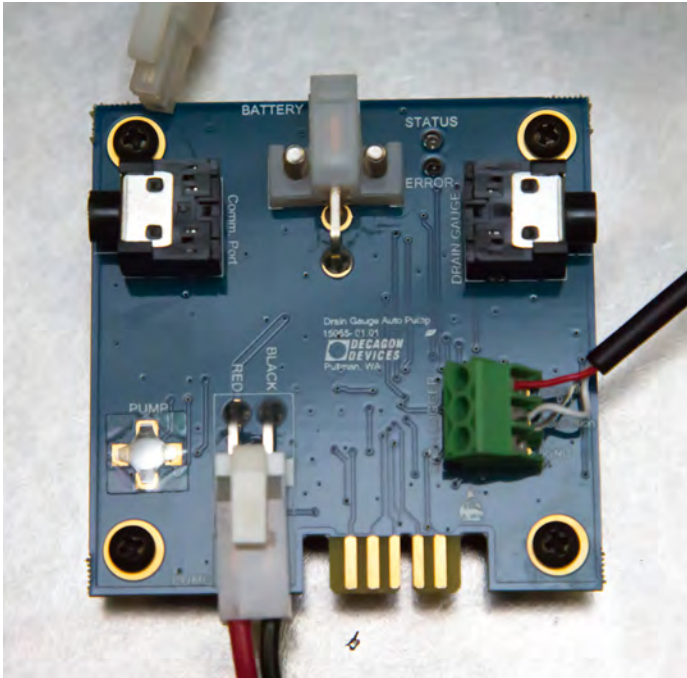

Figure 10: AutoPump face plate with sensor connections and cable glands on case lid.

8.3 Sample Collection Tube Connection

There are two 6 mm push-to-connect fittings on the back end of the case labeled “In” and “Out” (Figure). The sample tube coming from the Drain Gauge G3 should be connected to the “In” port. The AutoPump comes with a 1 m length of 6 mm O.D. Polyurethane tubing that should be connected to the “Out” port of the AutoPump. The tubing coming out of the AutoPump can be run off into the field away from the measurement area of the Drain Gauge G3 or connected into additional collection bottles on the surface. It is best to store additional collection bottles in a buried box to help keep sample temperatures down.

Note: For the older Drain Gauge G3 with the larger 1/2” O.D. tubing the tubing can be replaced with with a 6 mm Polyurethane Tubing or

adapted down the 6 mm connection using a reducer. Contact Decagon Support if you would like to request replacement tubing.

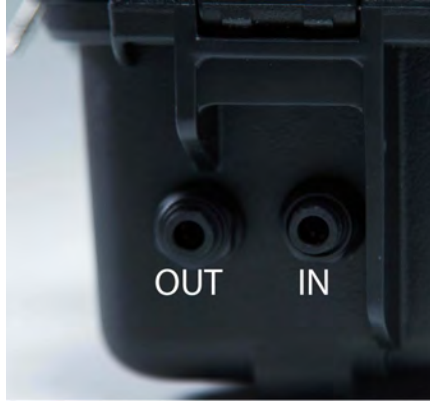

Figure 11: 6 mm push-to-connect fittings for connection sampling tube “In” and Sample Tube “Out”

8.4 AutoPump Configuration

The AutoPump sits between the data logger and a Drain Gauge sensor (either the G3 Drain Gauge or the CTD+Drain Gauge). From the perspective of the data logger, the AutoPump appears as a Drain Gauge sensor; from the perspective of the sensor, the AutoPump looks like a data logger.

The pump and the AutoPump board are both powered by a 12 V lead-acid battery connected via the 12 V Power Input jack. Each jack is labeled on the circuit board, and a diagram is provided in Figure 10. The connectors on the AutoPump circuit board are provided in Table 3. A Data Logger connects to the AutoPump via the Data Logger solder pads on the AutoPump board. Since the AutoPump does not derive its power from the data logger, and since the Campbell data loggers do not read the DDI string, a Campbell logger can connect to just the data and ground pads of the AutoPump.

Table 3: AutoPump Circuit Board Connectors

Peripheral	ID	Circuit Board Connector
Drain Gauge	J1	Stereo Jack SJ-D-5
12 V Power Input	J5	Molex 39-29-5023, 2 CKT R/A HEAD-ER
Pump	P4	2PINRAHDR.15, 2 position, 0.156 inch pitch, right angle header
Data Logger	n/a	Solder Pads

When you power the AutoPump, it takes an initial reading from the Drain Gauge, so it always has a value ready to report to the data logger. After that point, AutoPump attempts to read the Drain Gauge sensor once every minute. The AutoPump stores the values from the startup string, and interprets the pressure value to turn the pump on or off. The AutoPump is programmed with fixed upper (306 mm H₂O) and lower (20 mm H₂O) threshold limits. When the water level reaches the upper threshold, the AutoPump turns on the pump; when the water level decreases to the lower threshold, the AutoPump turns the pump off. The pushbutton on the circuit board toggles pump power, and can be used to verify that the pump is operational and hooked up correctly.

The AutoPump includes a Thomas Gardner SR10/50 peristaltic pump. This pump can pump either air or water so it is safe to run it dry; however, the AutoPump minimizes the duration of time for which the pump runs dry to conserve battery life. While pumping, if the AutoPump misses a reading due to the sensor detaching or if it receives an error for the pressure, the AutoPump shuts off the pump. In the event that a sensor is not attached, the AutoPump sends a response containing error values for the three readings (pressure, temperature, conductivity) to the Data Logger when polled. If the water level stops decreasing while pumping, the AutoPump turns off

the pump; if at this point the water level is above the upper threshold, AutoPump does not turn the pump on again until after a reset (either via a power cycle, or via manually pressing the ‘PUMP’ button on the board). In all cases, the AutoPump continues to read the Drain Gauge regularly and provide the most recent reading to the data logger.

Upon receiving a power signal from the logger, the AutoPump relays the reading most recently received from the Drain Gauge using the DDI-Serial format (i.e. AutoPump sends the Startup String). The AutoPump also responds to SDI-12 commands: Measure and Concurrent commands require reading the sensor; Continuous and Verify commands relay the values from the most recent periodic reading, with the exception of R3 which initiates a new read from the Drain Gauge.

8.5 Status LED and Error LED

The AutoPump takes one reading from the Drain Gauge sensor every minute. When it takes a reading, it turns off the pump if:

1. a sensor is not attached.
2. the Drain Gauge returns an error (CRC, invalid sensor type, pressure error value).
3. the water level stops decreasing over time (i.e. either holds constant or increases).

If during the time that the pump is running the AutoPump detects four occurrences of the water level reading higher than the previous reading, the AutoPump determines that the pump is not making progress and turns off the pump. Upon turning off the pump if the water level is above the Maximum threshold, then the AutoPump marks the pump as disabled and declines to turn it on again until the user resets the board or manually requests to turn on the pump via the push button switch on the AutoPump. The Status LED and the Error LED flash in different patterns to reflect the current operational state of the pump and AutoPump. Refer to the Troubleshooting section for LED translations.

9 Troubleshooting

If you encounter problems with the CTD-Drain Gauge the G3 Drain Gauge, or the AutoPump they most likely manifest themselves in the form of incorrect or erroneous readings. Before contacting Decagon about the sensor, refer to these troubleshooting solutions.

Table 4: Troubleshooting Quick Guide

If this problem occurs:	Refer to:
AutoPump	
AutoPump does not complete startup	Problem #1
Water level reaches maximum	Problem #2
No sensor attached	Problem #3
Drain Gauge sensor returns pressure error	Problem #4
Water stops decreasing before minimum	Problem #5
Data logger fails to interface	Problem #6
Drain Gauge	
Sensor communication error	Problem #7

1. PROBLEM:

AutoPump does not complete startup LED stays constantly on and Pump does not turn on and data logger cannot obtain readings.

LED FLASH CODE: Stays constantly on.

SOLUTION:

Cycle power to the Autopump.

2. PROBLEM:

Water level reaches maximum threshold.

LED FLASH CODE: 3 seconds on and 2 seconds off. Pump turns on.

SOLUTION:

Under normal conditions, pump stays on until water level reaches the minimum threshold.

3. PROBLEM:

No sensor attached

LED FLASH CODE: LED blinks on, 5 sec, then Pumps turns off and does not come on, data logger reading contains all errors.

SOLUTION:

Attach functional Drain Gauge

4. PROBLEM:

Drain Gauge sensor returns Pressure Error.

LED FLASH CODE: LED Blinks on, 5 sec. off Pump turns off Data Logger reading contains pressure error.

SOLUTIONS:

Check Drain Gauge; Pump should turn on again when water reaches the maximum threshold.

5. PROBLEM:

Water level stops decreasing before reaching minimum threshold

LED FLASH CODE: Blink on, 5 seconds off, pump turns off after four measurements where water level \geq previous water level.

SOLUTIONS:

Use pushbutton to test pump operation Check hose lengths and connections Pump turns on again when water reaches the maximum threshold.

6. PROBLEM:

Water level stops decreasing above maximum threshold.

LED FLASH CODE: 1 sec. on, 1 sec. off. Pump turns off after four measurements where water level \geq previous water level. Pump does not come on again.

SOLUTIONS:

Cycle power to the AutoPump or switch pump on/off via ‘PUMP’ pushbutton.

7. PROBLEM:

Data logger fails to interface.

SOLUTIONS:

1. Check to make sure the connections to the data logger are both correct and secure.
2. Ensure that your data logger batteries are not dead or weakened.
3. Check the configuration of your data logger in ECH₂O Utility or DataTrac to make sure you have selected CTD-Drain Gauge.
4. Ensure that you are using the most up to date software and firmware. You can find the most up to date version of the software and firmware at www.decagon.com/support.

8. PROBLEM:

Sensor communication error

SOLUTIONS

1. Ensure that your sensors are installed according to the “Installation” section of this manual.
2. Check sensor cables for nicks or cuts that could cause a malfunction.
3. Check the pressure transducer tube to ensure that it is not clogged or damaged.

10 Further Reading

Gee, G. W., B. D. Newman, S. R. Green, R. Meissner, H. Rupp, Z. F. Zhang, J. M. Keller, W. J. Waugh, M. van der Velde, and J. Salazar, (2009). Passive wick fluxmeters: Design considerations and field applications. *Water Resour. Res.*, 45, W04420, doi:10.1029/2008WR007088.

11 Declaration of Conformity

11.1 Em50 CE Compliance

Application of Council Directive:	2004/108/EC and 2011/65/EU
Standards to which conformity is declared:	EN 61326-1:2013 and EN 50581:2012
Manufacturer's Name:	Decagon Devices, Inc 2365 NE Hopkins Ct. Pullman, WA 99163 USA
Type of Equipment:	Gee Passive Capillary and Lysimeter Drain Gauge
Model Number:	G3
Year of First Manufacture:	2010

This is to certify that the Drain Gauge G3, manufactured by Decagon Devices, Inc., a corporation based in Pullman, Washington, USA meets or exceeds the standards for CE compliance as per the Council Directives noted above. All instruments are built at the factory at Decagon and pertinent testing documentation is freely available for verification.

Note: Root inhibitor not included in Drain Gauges shipped to Europe to comply with CE requirements.

Index

- Calibration, 27
- CE Compliance, 44
- Customer Support, 1
- Declaration of Conformity, 43
- Divergence Control Tube (DCT), 5
- Drain Gauge
 - Assembly, 15
 - Components, 6
 - Depth of Assembly, 7, 13
 - Installation Instructions, 5, 12
 - Priming, 21
- Drainage
 - Calculating, 24
- Em50
 - CE Compliance, 43
- Email, 1
- Fax, 1
- Installation, 5, 12
 - Depth, 13
 - Location, 12
 - Making the Hole, 16
 - Soil Disturbance, 11
- Intact Soil Monolith, 12, 13
- Phone, 1
- piston Pump, 23
- Root Incursion, 7
- SDI-12 Communication, 31, 33
- Seller's Liability, 4
- Serial String, 31
- Specifications, 2
- U Connector, 20
- Warranty, 4
- Water Collection, 23